

---

# Merging unit ENMU

---

Manual

# Table of content

<b>Introduction</b>	<b>3</b>
<b>Glossary</b>	<b>4</b>
<b>1 General information</b>	<b>5</b>
<b>2 Features</b>	<b>6</b>
2.1 Sampled values	6
2.2 Phasor measurement	6
2.3 Redundancy	6
2.4 Time sync	7
2.5 Fault recording	8
<b>3 Specification</b>	<b>9</b>
3.1 Operating conditions	9
3.2 Measurement inputs	9
3.3 Digital inputs/outputs	10
3.4 Interfaces	11
3.5 Power supply	12
3.6 Dimensions	12
<b>4 Operation</b>	<b>14</b>
4.1 Package contents	14
4.2 Before installation	14
4.3 Mounting	14
4.4 Terminal connections	15
4.5 LED indications	16
4.6 Configuring	16
4.7 Default settings	17
<b>5 Maintenance</b>	<b>19</b>
<b>6 Transporting, packing and storing</b>	<b>20</b>
<b>7 Warranty information</b>	<b>21</b>
<b>8 Disposal</b>	<b>22</b>
<b>Appendix A. Accuracy tests</b>	<b>23</b>
<b>Appendix B. Connection diagrams</b>	<b>25</b>

## Introduction

The Manual contains information on functionality, recommendations for usage, maintenance, packing, transportation, storage, getting technical support as well as connection diagrams to electrical grid and digital interfaces.

Read this manual carefully before using the device.

### Typical users

This document is intended for engineers as well as installation, operation and maintenance personnel.

### Validity range

This manual applies to all ENMU modifications with firmware v. 1.2.2.

### Support

Engineering Center Energoservice  
Kotlasskaya st, 26  
Arkhangelsk, Russia, 163046

Website: [www.enip2.com/support](http://www.enip2.com/support)

Phone: +7 (8182) 65-75-64

E-mail: [enip2@ens.ru](mailto:enip2@ens.ru)



#### ATTENTION:

- Use ENMU only as described in this manual;
- ENMU should be installed, operated and maintained by qualified personnel only;
- Do not use any cleanser except recommended;
- Save ENMU from impact;
- Before connecting ENMU, ensure that the local power supply conditions agree with the specifications on the label on the ENMU.



#### NOTICE:

- The information contained in this document is subject to change without notice;
- New features may be added to devices without notice.

## Glossary

- CT – current transformer;
- PPS – pulse per second;
- Process Bus – process bus according to IEC 61850 9-2;
- PRP - Parallel Redundancy Protocol (IEC 62439-3 Clause 4);
- VT – voltage transformer;
- PTP – precision time protocol (IEEE 1588);
- SV – Sampled Values (IEC 61850-9-2).

# 1 General information



Figure 1.1. ENMU appearance.

ENMU is a stand-alone merging unit (SAMU) as defined by IEC 61869-13. ENMU provides Sampled Values (SV) according to Implementation Guidelines for Digital Interface to Instrument Transformers using IEC 61850-9-2LE. ENMU has optical fiber Fast Ethernet 100Base-FX interfaces. LAN A and LAN B can be configured to operate as a PRP node to provide seamless failover.

ENMU digitizes analog input signals and transmits synchronized SV data to Process Bus via optical interfaces (max. 4 streams). SV stream is used as an input signal for protection devices, power meters, PMUs etc. In addition, ENMU supports data transmission via IEC-60870-104 and IEEE C37.118.

Ordering information:

#### Rated values

1/100 – 1 A / 57,7(100) V  
5/100 – 5 A / 57,7(100) V

## ENMU-X-X-220-X-X

#### Digital inputs/outputs

16/10 – 16 DI, 10 DO  
-- NA

#### Interfaces group 1

E3A1 – 3 × Ethernet 100Base-TX, 1 × RS-485 (sync)  
FX2E1A1 – 2 × Ethernet 100Base-FX, 1 × Ethernet 100Base-TX, 1 × RS-485 (sync)  
FX2E1ST1 – 2 × Ethernet 100Base-FX, 1 × Ethernet 100Base-TX, 1 × fiber ST (sync)

#### Interfaces group 2

E3A2C1 – 3 × Ethernet 100Base-TX, 2 × RS-485, 1 × CAN  
FX2E1A2C1 – 2 × Ethernet 100Base-FX, 1 × Ethernet 100Base-TX, 2 × RS-485, 1 × CAN

## 2 Features

### 2.1 Sampled values

ENMU transmits up to four IEC 61850-9-2LE streams. Two of which are SV80 with sampling rate 4000 Hz (80 samples per cycle) and the other two are SV256 with sampling rate 12800 Hz (256 samples per cycle). Streams can be configured to contain values of measuring precision or protection precision current.

ENMU is connected to Process Bus via fiber optic Ethernet 100Base-FX LAN A and LAN B interfaces.

### 2.2 Phasor measurement

ENMU supports phasor measurement as defined by IEEE C37.118. Data rate up to 100 frames per second.

Measured values:

Parameter	Symbol	Phasors	Analog (RMS)
Phase voltage	$U_A, U_B, U_C$	+	+
Phase current (measurement)	$I_A, I_B, I_C$	+	+
Phase current (protection)	$I_{Ap}, I_{Bp}, I_{Cp}$	+	+
Active power	$P_A, P_B, P_C$	-	+
Reactive power	$Q_A, Q_B, Q_C$	-	+
Frequency	F	-	+
ROCOF	dF	-	+
Zero sequence voltage	$U_0$	+	+
Zero sequence current (measuring)	$I_0$	+	+
Zero sequence current (protection)	$I_{0p}$	+	+
Zero sequence active power	$P_0$	-	+
Zero sequence reactive power	$Q_0$	-	+

### 2.3 Redundancy

ENMU supports PRP redundancy as of IEC 62439-3. An example of a redundant network implementation is show on the figure below.

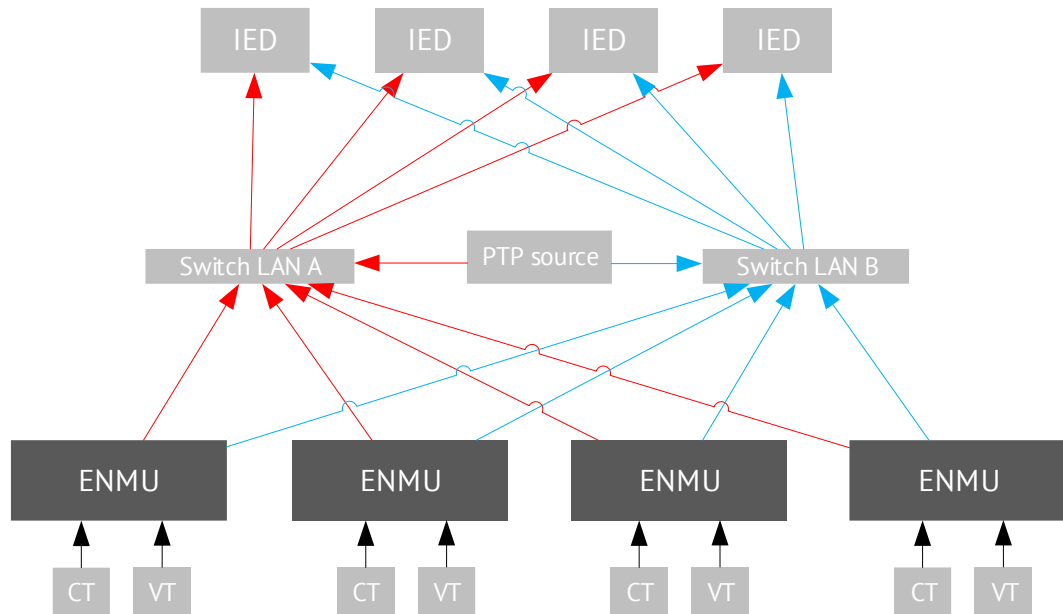

Figure 2.1

By default, PRP for SV streams is disabled.

## 2.4 Time sync

2.4.1 Accuracy of internal clock is within 1  $\mu$ s when synchronized. Clock error without synchronization is within 0.4 seconds per day.

ENMU can be configured to use one of the following synchronization methods:

- PTPv2
- PPS1, IRIG-B or IRIG-A

2.4.2 ENMU can be synchronized via LAN A or LAN B with PTP. Available settings:

Parameter	Values
Domain	0...127
Delay mechanism	Peer to peer, end to end
Unicast delay request	Enable, disable
Delay request interval	0.125, 0.25, 0.5, 1, 2, 4, 8, 16, 32 s
Announce interval	1, 2, 4, 8, 16 s
VLAN ID	0...4095

2.4.3 ENMU can be synchronized via dedicated fiber optic interface with PPS, IRIG. For PPS1 parameters see [Section 3.4](#).

If ENMU has not received PPS or IRIG signal for 60 seconds, SV streams will be mark as not synchronized.

2.4.4 The possible value of *SmpSync* field in SV stream are:

- 0 when not synchronized;
- 1 (local) when synchronized.

## 2.5 Fault recording

ENMU uses built-in memory for storing oscillograms. Configurable setpoints activate fault recording. Values  $I_a$ ,  $I_b$ ,  $I_c$ ,  $I_0$ ,  $U_a$ ,  $U_b$ ,  $U_c$ ,  $U_0$  are recorded with sampling rate 32, 64, 128 or 256 samples per cycles. Max record length is 250 seconds.



## 3 Specification

### 3.1 Operating conditions

Permissible operating condition:

Table 3.1

N°	Condition	Value
1	Temperature, °C	-40...+70
2	Relative humidity, %	5-95 non-condensing
3	Operation mode	continuous
4	Loading time	<30 sec
5	MTBF	100000 h
6	Service life	15 years
7	Seismic sustainability	Up to VI degree MSK-64
8	Input frequency, Hz	50±5

#### 3.1.1 Normal condition see in table 4.4.

Table 3.2

Condition	Normal value (or normal range)	Variation
Temperature, °C	20	±5
Relative humidity, %	Up to 98	
Atmospheric pressure, kPa (mmHg)	65÷106.7 (488÷800)	
Strength of the magnetic field	Magnitude of Earth's magnetic field	0.5 mT at (50/60±1) Hz
Supply frequency, Hz	50	±5
Supply voltage AC	sinusoidal	Voltage distortion up to 5 %

### 3.2 Measurement inputs

#### 3.2.1 VT output connected to terminals U<sub>a</sub>, U<sub>b</sub>, U<sub>c</sub>, 3U<sub>0</sub>.

Table 3.3

Voltage input parameter	Value
Nominal phase voltage, V	57.7
Input channels	U <sub>a</sub> , U <sub>b</sub> , U <sub>c</sub> , 3U <sub>0</sub>
Voltage measurement range, % from nominal voltage	5...200
Voltage accuracy class	0.2
Sampling rate	4000/12800 Hz
Delay before transmit	Up to 100 μs
Power consumption	<0.1 VA

#### 3.2.2 Measuring CT output connected to terminals I<sub>a</sub>, I<sub>b</sub>, I<sub>c</sub>, I<sub>0</sub>.

Protective CT output connected to terminals I<sub>a</sub>, I<sub>b</sub>, I<sub>c</sub>.

Table 3.4

Current input parameter	Measuring input	Protective input
Nominal current, A	1 or 5	
Input channels	$I_a, I_b, I_c, I_0$	$I_a, I_b, I_c$
Measurement range, % from nominal current	1...200	10...4000
Accuracy class	0.2	6TPS
TVE, %	<1	-
Sampling rate	4000/12800 Hz	
Delay before transmit	Up to 100 $\mu$ s	
Power consumption	<0.1 VA	

Current overload capability:

Table 3.5

Condition	Value
Continuous	25 A
15 s	50 A
1 s	250 A
dynamic	1000 A

3.2.3 If conditions do not match those specified in Table 3.2, ENMU has additional measurement error according to following table.

Table 3.6

Condition	Value	Added error, %
Temperature, °C	-40...+70*	$\pm 0.05/10^\circ\text{C}$
Strength of the magnetic field, mT	0.5	$\pm 0.1$

### 3.3 Digital inputs/outputs

The ENMU optionally has a digital inputs and outputs.

Table 3.7. Digital input specifications

Parameter	Value
Quantity	16
Type	«wet contact»
Voltage, V	220 (DC)
ON threshold, V	Configurable: 1...300
OFF threshold, V	Configurable: 1...300
Bias current, mA	Configurable: 0.05...3.75
Inrush current, mA	Configurable: 0.05...105
Inrush time, ms	Configurable: 0...120

Table 3.8. Digital output specifications.

Parameter	D01-D03	D04-D010
Quantity	3	7
Type	Solid-state relay	Electromechanic relay
$U_{max}$ , V	400 DC	300 DC, 400 AC
$I_{rated}$ , A	1.35 (AC/DC)	6 ( $I_{max} = 15$ )
$I$ , A	0.1 (DC)	0.45 (at 220 V DC)
operate/release time, ms	5/0.13	5/1

## 3.4 Interfaces



### 3.4.1 Time synchronization via PPS or IRIG. Protocol is determined automatically.

Table 3.9

Interface	Protocols	Standard	Type
<b>SYNC</b>	PPS 1, IRIG-A(-B)	IEC 60044-8 ed. 1.0	ST, multimode 50/125 $\mu\text{m}$ , 820 nm

PPS parameters:

<b>Trigger level</b>	50 % of maximum brightness
<b>PPS impulse duration</b>	More than 10 $\mu\text{s}$
<b>PPS step</b>	More than 500 $\mu\text{s}$
<b>PPS signal source</b>	ENCS-2-1.1.1 + ESMC or other

### 3.4.2 Process bus

LAN A1 and LAN B1 interfaces can be configured for independent operation or in PRP mode.

Table 3.10

Interface	Usage	Standard	Type
<b>LAN A1, LAN B1</b>	SV streaming; configuring; FTP; PTPv2	Ethernet 100Base-FX, PRP according to IEC 62439-3	Duplex LC, 100 Mb/s, multimode 50/125 $\mu\text{m}$ , 1300 nm

### 3.4.3 Substation bus

Table 3.11

Interface	Usage	Standard	Type
<b>LAN A2, LAN B2</b>	MMS server, GOOSE publisher and subscriber, SNTP	Ethernet 100Base-FX, PRP according to IEC 62439-3	Duplex LC, 100 Mb/s, multimode 50/125 $\mu\text{m}$ , 1300 nm

### 3.4.4 Additional interfaces

Table 3.12

Interface	Usage	Standard	Type
<b>LAN 1</b>	Configuring SV; data transmit over IEEE C37.118.2; FTP	Ethernet 100Base-FX	Duplex LC, 100 Mb/s, multi- mode 50/125 $\mu$ m, 1300 nm
<b>LAN 2</b>	Configuring MMS and GOOSE; data transmit over IEC 61850	Ethernet 100Base-FX	Duplex LC, 100 Mb/s, multi- mode 50/125 $\mu$ m, 1300 nm

### 3.5 Power supply

ENMU has one universal AC/DC power supply input for connection to power source. Permitted supply voltage ranges see in Table 3.13.

Table 3.13

Parameter	Value
AC voltage	100...265 V, 47...63 Hz
DC voltage	120...370 V
Power supply consumption	max 30 VA

### 3.6 Dimensions

Dimensions in mm shown below in Fig. 3.1

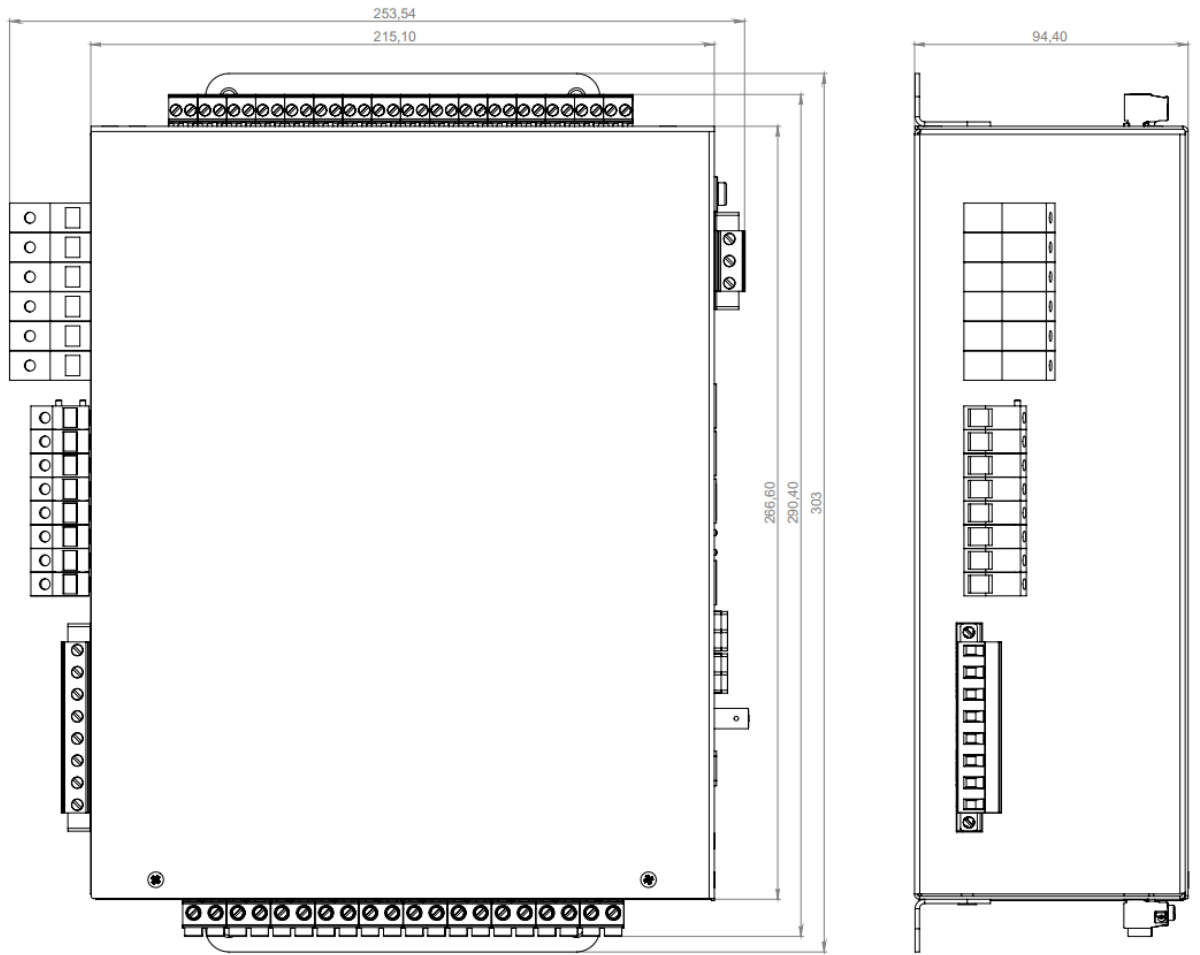

Figure 3.1. Dimensions (in mm).

## 4 Operation

### 4.1 Package contents

Table 4.1

Merging unit	ENMU
Mounting brackets	x2
CD containing manual and software (ES Configurator, BootLoader, ES Find IP)	ENMU.422189.001

### 4.2 Before installation

After receiving ENMU from distributor, make sure that the package has no defects.

Unpacking ENMU, check the package contents.

Compare characteristics in passport with label on front side of device.

Before connecting or disconnecting ENMU to digital interface or measuring inputs, make sure that all sources of power supply are disconnected.

ENMU connects only to current and voltage transformers with suitable characteristics.

IEC 61850-9-2LE Bus shall be connected in accordance with the operational documentation.

Do not use ENMU in explosive or corrosive environment.

Save ENMU from heating above 70 °C, large temperature variations and strong electromagnetic fields.

### 4.3 Mounting

For safety, read the instructions in this manual before mounting and operation. Only qualified personnel shall perform installation.

The ENMU grounding terminal  always must be connected to the protective conductor.

ENMU has 2 ear brackets for cabinet surface mounting. For dimensions see Fig. 3.1.

## 4.4 Terminal connections

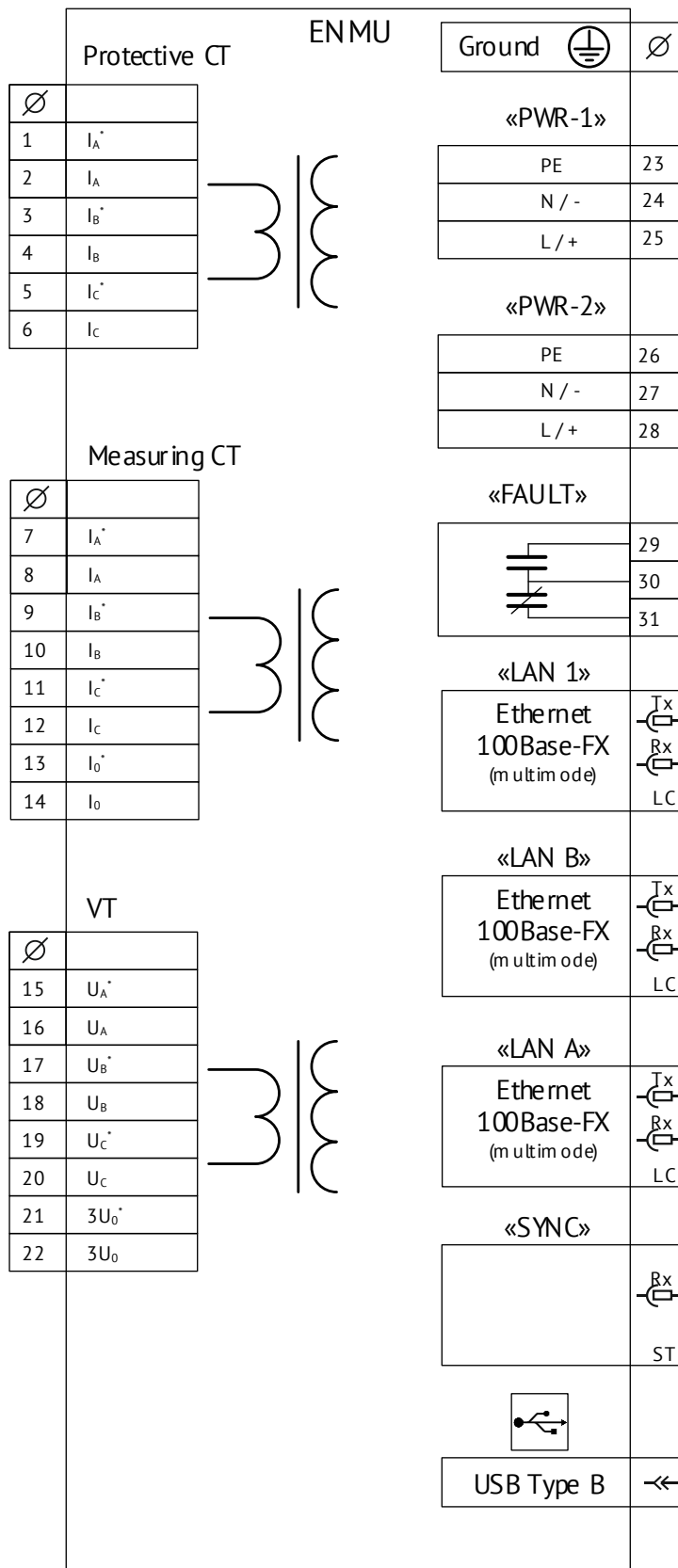

Figure 4.1



Tightening torque is 0.5 to 0.6 N·m

Terminals	Recommended wire size
Power supply	2.5 mm <sup>2</sup> wires (AWG 14)
Voltage input	4 mm <sup>2</sup> wires (AWG 12)
Measuring current input	6 mm <sup>2</sup> wires (AWG 10)
Protective current input	16 mm <sup>2</sup> wires (AWG 5)

ENMU must be connected to Process Bus using optical fiber cable.

Optical interfaces	Parameters
LAN A, LAN B, LAN 1	LC socket, multimode 50/125 μm, 1300 nm, UPC
Sync	ST socket, multimode 50/125 μm, 820 nm

## 4.5 LED indications

Two LEDs groups on the right side indicate the current state.

LED	Description	
	Constant	Blinking
LAN A1	LAN A1 link up	LAN A network activity
LAN B1	LAN B1 link up	LAN B network activity
LAN 1	LAN 1 link up	LAN 1 network activity
LAN A2	LAN A2 link up	LAN A network activity
LAN B2	LAN B2 link up	LAN B network activity
LAN 2	LAN 2 link up	LAN 1 network activity

## 4.6 Configuring

Configuration supported by **ES Configurator** via any LAN1 interface. The latest version is available at <https://enip2.ru/software/esconfigurator.zip>

PC with Windows XP operating system or newer and .NET Framework 4 installed is required. Download .NET Framework 4 distributive at [www.microsoft.com/downloads](http://www.microsoft.com/downloads).

To launch the program, unzip files and run *ESConfigurator.exe*. Main form of the application is shown in Figure 4.2.



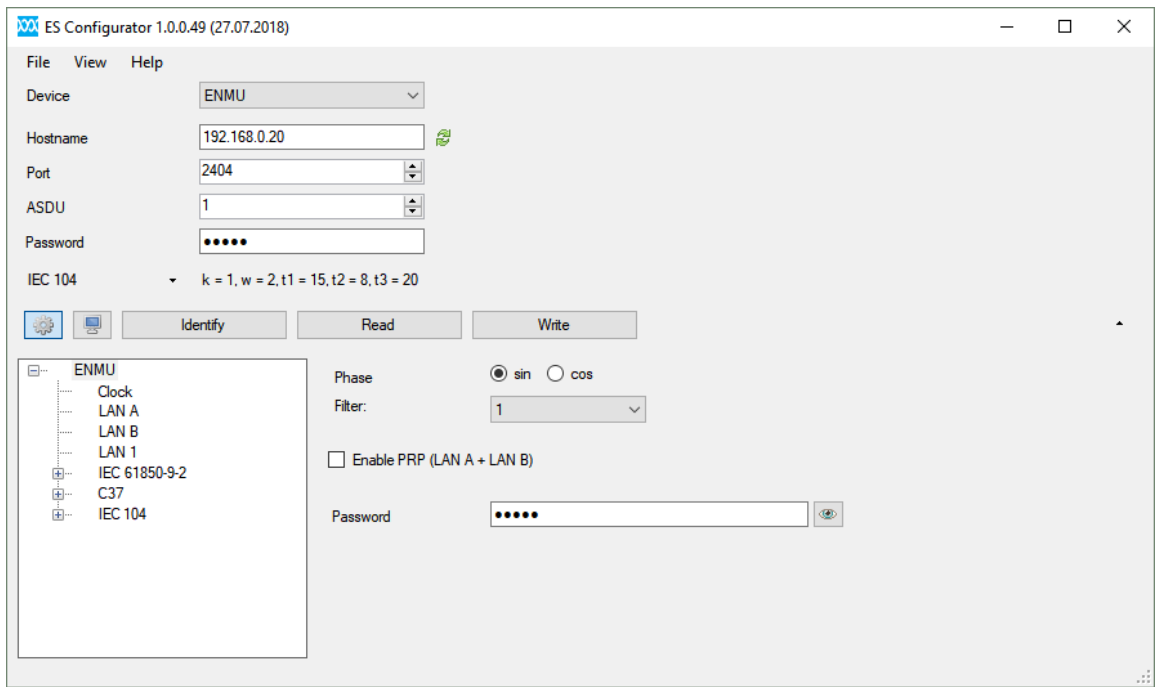

Figure 4.2

See ES Configurator manual for detailed information.

## 4.7 Default settings

### 4.7.1 Ethernet interfaces

Parameter	LAN A1	Lan B1	Lan 1
IP address	192.168.0.20	192.168.0.21	192.168.0.22
Mask	255.255.252.0	255.255.252.0	255.255.252.0
Gateway	192.168.0.1	192.168.0.1	192.168.0.1
DHCP	disable	disable	disable
NetBIOS	enable	enable	enable

Parameter	LAN A2	Lan B2	Lan 2
IP address	192.168.0.10	192.168.0.11	192.168.0.12
Mask	255.255.252.0	255.255.252.0	255.255.252.0
Gateway	192.168.0.1	192.168.0.1	192.168.0.1
DHCP	disable	disable	disable
NetBIOS	enable	enable	enable

### 4.7.2 Time setting

Parameter	Value
Time source	PTP
Domain	0
Delay mechanism	End-to-End
Unicast delay request	disable
Delay request interval	4 s
Announce interval	2 s
VLAN ID	1

## 4.7.3 SV streams

Parameter	SV80-1	SV80-2
<b>State</b>	Enabled	Enabled
<b>Dataset</b>	Voltage, measuring precision current	Voltage, protection precision current
<b>SV ID</b>	ENS80pointMU01	ENS80pointMU01
<b>Interface</b>	LAN A	LAN A
<b>VLAN</b>	Disabled	Disabled
<b>Dst MAC</b>	01-0C-CD-04-01-FF	01-0C-CD-04-02-FF

Parameter	SV256-1	SV256-2
<b>State</b>	Enabled	Disabled
<b>Dataset</b>	Voltage, measuring precision current	Voltage, protection precision current
<b>SV ID</b>	ENS256MUnn01	ENS256MUnn02
<b>Interface</b>	LAN A	LAN B
<b>VLAN</b>	Disabled	Disabled
<b>MAC-address</b>	01-0C-CD-04-03-FF	01-0C-CD-04-04-FF

## 5 Maintenance

Maintenance should be performed according to this manual and by qualified personnel only.

For preventive maintenance, follow the instruction below:

- Disconnect power supply, digital interfaces, measuring inputs
- Remove dust
- Check device for defects
- Check mounting
- Connect power supply, digital interfaces, measuring inputs.

For cleaning use non-abrasive detergent or 70% ethanol-water solution.

Do not open the housing during operation. Opening the ENMU voids the warranty.

## 6 Transporting, packing and storing

ENMU shall be transported in covered transport (railway, car, aviation) at temperature from -50 to +70°C and relative humidity 95 % (at +30°C). Save ENMU from impact during transporting.

ENMU is packed in a case. Package contents are listed on page 14.

Net weight 3 kg.

Gross weight up to 4 kg.

Store the device in a dry and clean place. Storage conditions are listed below:

Condition	Device in manufacturer package	Device without manufacturer package
Temperature	+5...+40 °C	10-35 °C
Relative humidity	80% (at +25 °C)	80% (at 25 °C)

## **7 Warranty information**

The manufacturer offers the customer a 36-month functional warranty on the instrument for faulty workmanship or parts from date of dispatch from the distributor. In all cases, this warranty is valid for 48 months from the date of production. This warranty is on a return to factory basis. The manufacturer does not accept liability for any damage caused by instrument malfunction. The manufacturer accepts no responsibility for the suitability of the instrument to the application for which it was purchased. Failure to install, set up or operate the instrument according to the instructions herein will void the warranty. Only a duly authorized representative of the manufacturer may open your instrument. Failure to do so may damage the electronic components and will void the warranty.

## **8 Disposal**

At the end of its useful life, the device must be disposed of in accordance with the rules, regulations and methods in force at the disposal site. Do not dispose of the device with household waste. At the end of the life of the device, take it to the collection point for disposal, if it is provided by local regulations.

## Appendix A. Accuracy tests

Voltage amplitude and phase error graphs compared with the tolerance:

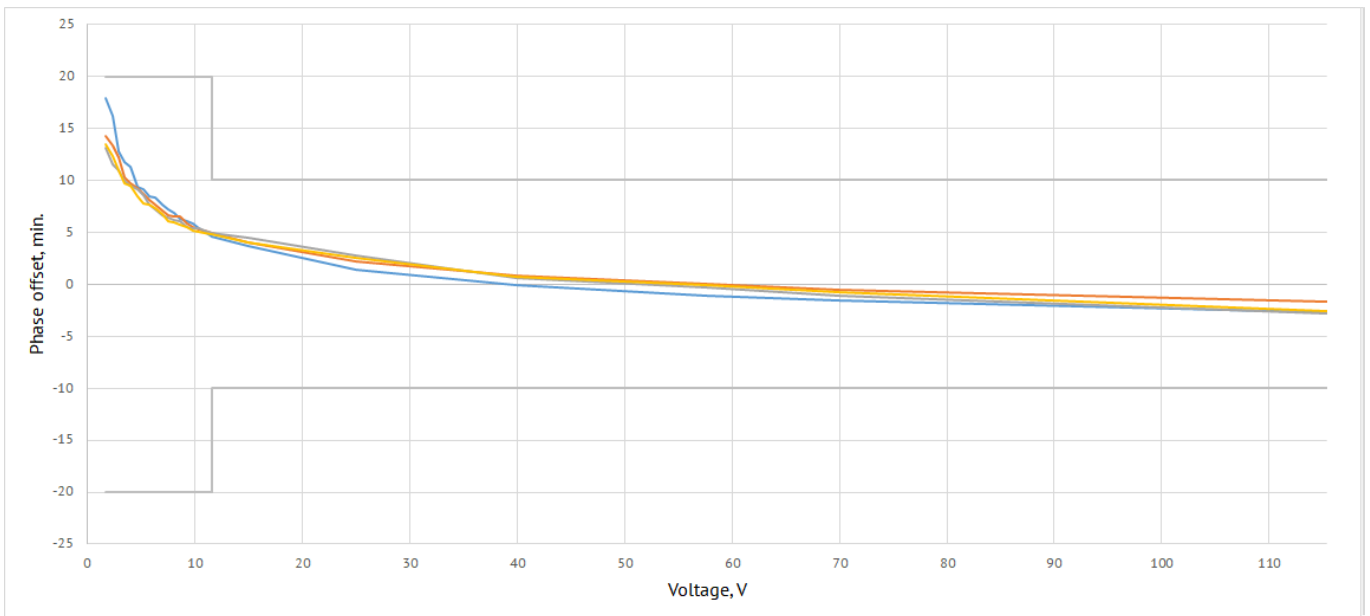
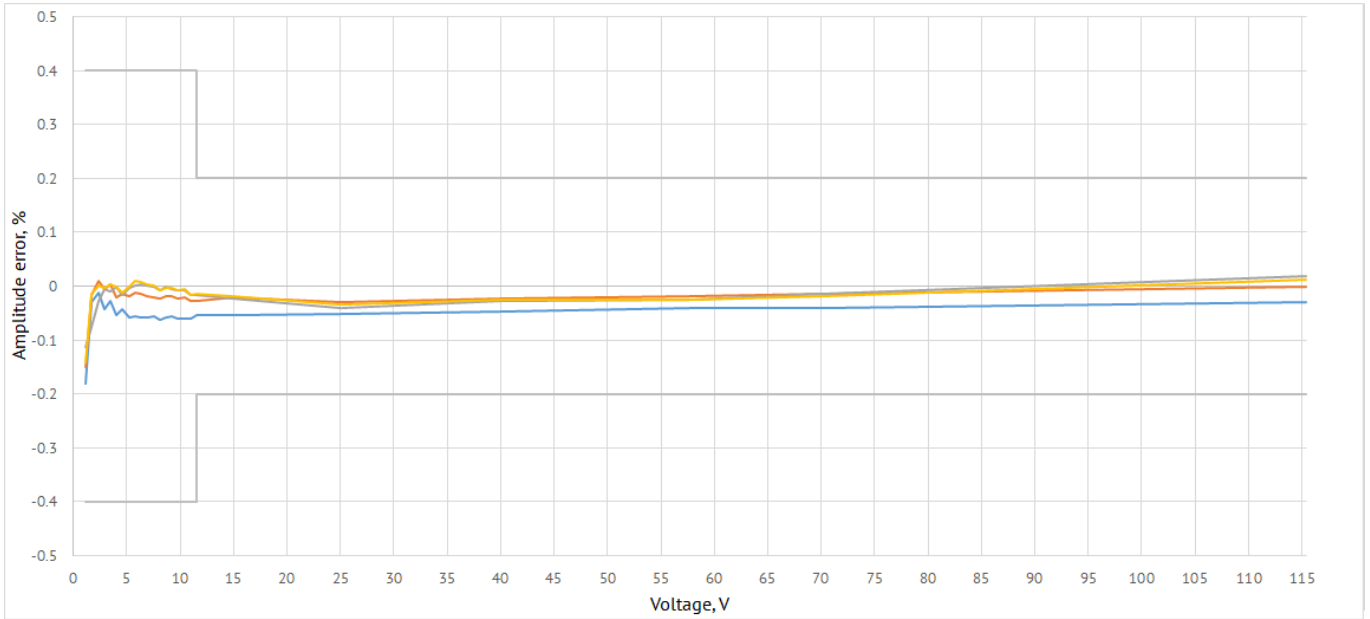

### Current amplitude and phase error graphs compared with the tolerance:

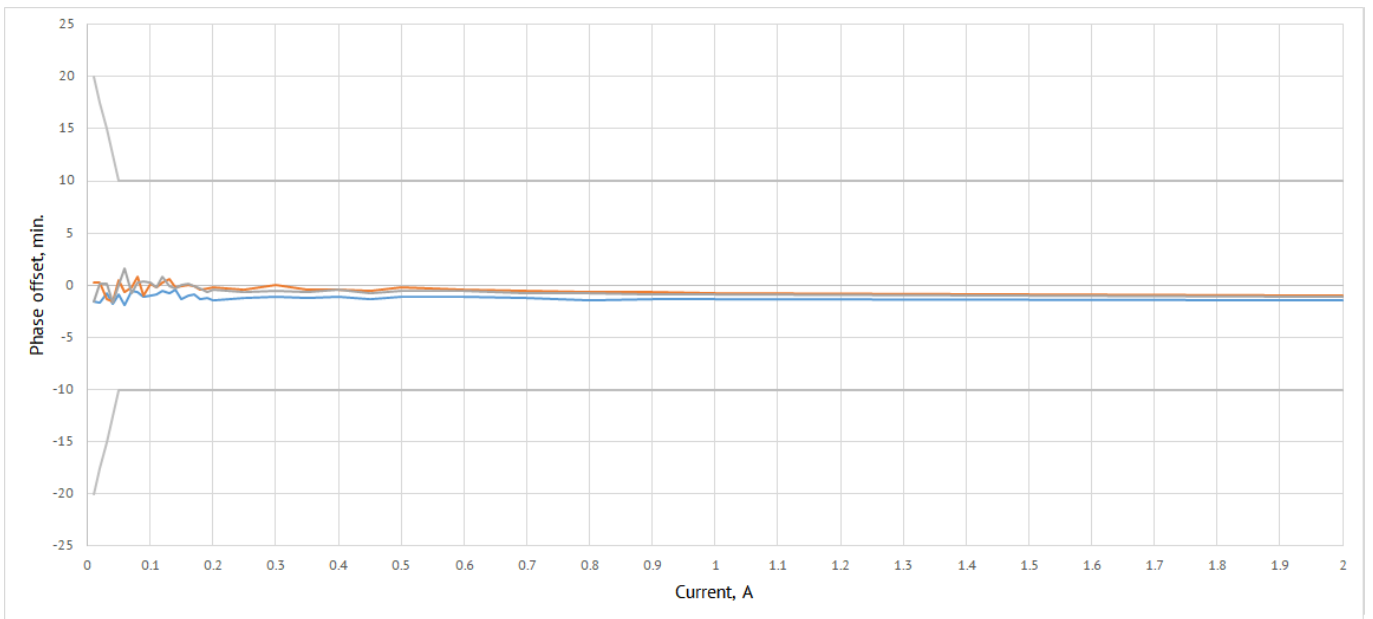
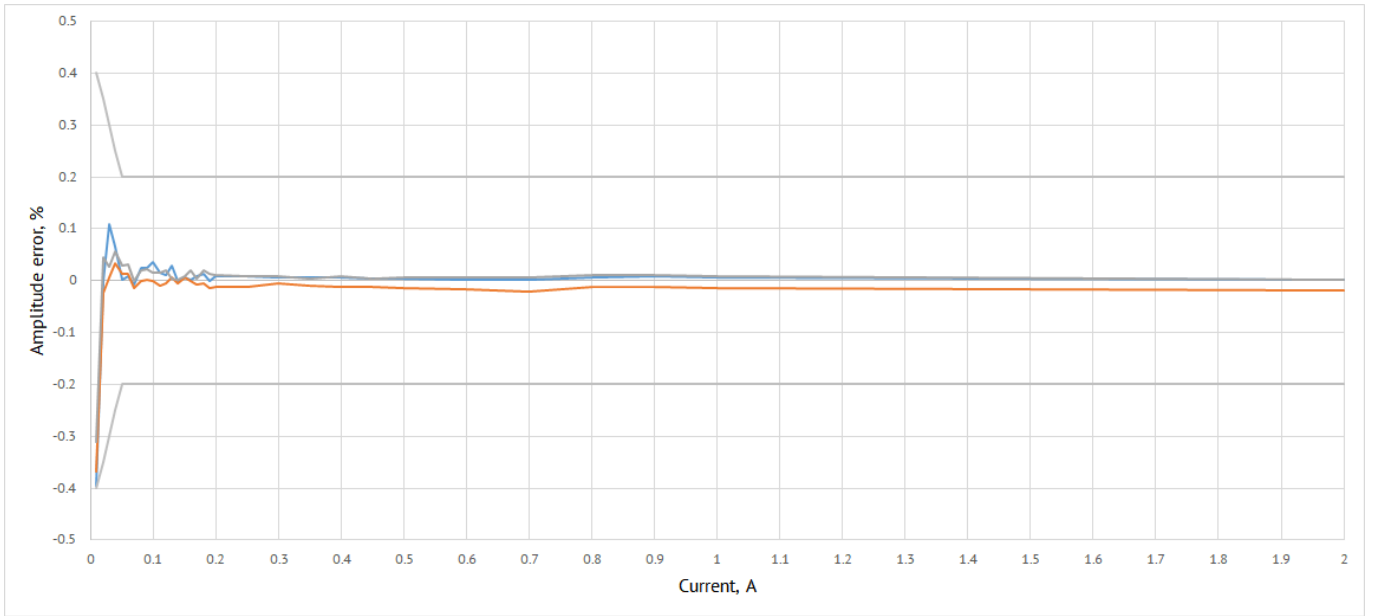



## Appendix B. Connection diagrams

